

# RUMMID<sup>®</sup>

Apparatus for  
Scientific and  
Industrial Research

Phone: ++49/511/824015  
          ++49/511/824016  
Fax:     ++49/511/824017  
e-mail: rubarth@aol.com

## Rubarth Apparate GmbH

Mergenthalerstrasse 8, D-30880 Laatzen, Germany

OPERATING AND  
MAINTENANCE INSTRUCTIONS  
FOR  
CLIMATIC TEST CABINETS  
TYPE 4001 - 4701

Version E/40-45/12-96





## Table of Contents

	Page
<b>1</b>	<b>General View</b> 4
<b>2</b>	<b>General</b> 5
<b>3</b>	<b>Transportation and Storage</b> 5
<b>4</b>	<b>Installation</b> 5
<b>5</b>	<b>Power Supply</b> 6
<b>6</b>	<b>Operation</b> 6
<b>7</b>	<b>Temperature Control</b> 8
7.1	Temperature Controller 8
7.2	Setpoint Control 8
7.3	Programme Control 8
7.4	Programmable Timer for Alternating Temperatures 9
7.5	Example for a Dual Setpoint Daily Programme 11
7.6	Example for a Dual Setpoint Weekly Programme 14
<b>8</b>	<b>Temperature Protection</b> 17
8.1	Specimen Protection 17
8.2	Unit Protection 18
<b>9</b>	<b>Humidification</b> 18
9.1	Ultrasonic Humidification 18
9.2	Dehumidification 21
<b>10</b>	<b>Service and Maintenance</b> 22

Concerning the basic unit, please refer to the **extra-bold** printed chapters.

All further chapters are belonging to options.

Deutsch Diese Bedienungsanleitung ist erhältlich in Deutsch.

Version D/40-45/12-96

Français Ce mode d'emploi est disponible en Français.

Sur demande!

# 1 General View

## Control Panel

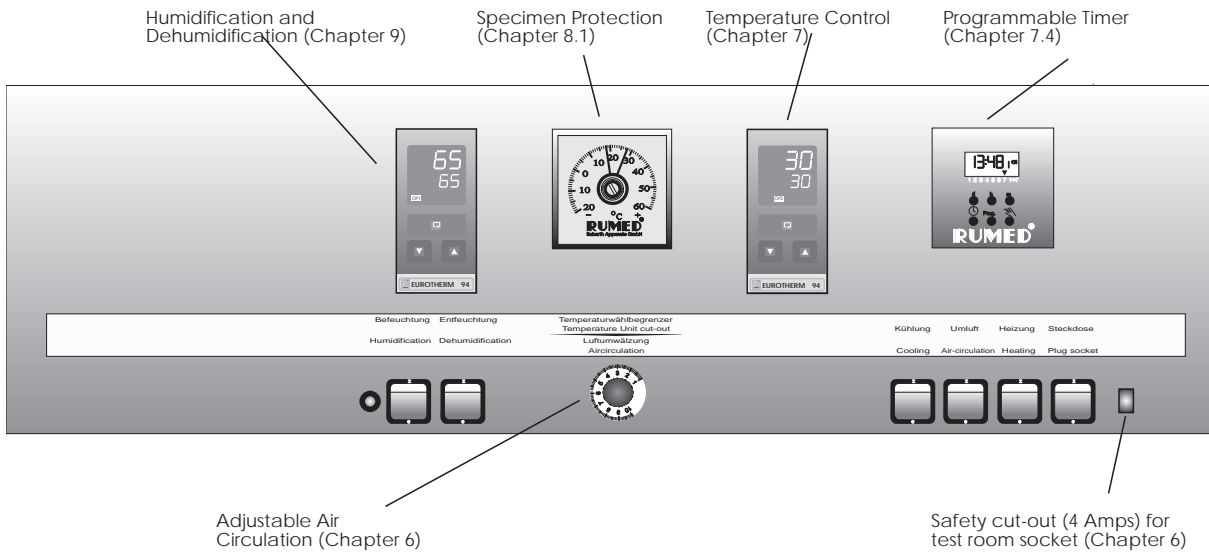

## Nameplate

The nameplate is located in the upper left edge of the door frame. In case of failures or for spare-part orders, please indicate the unit type (1) and the serial no. (2).

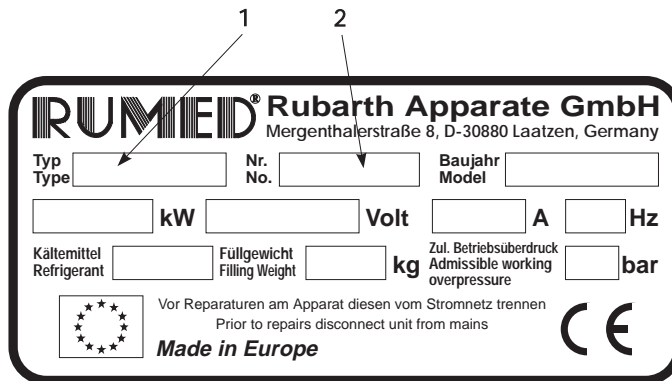

## 2 General

RUMED Climatic Test Cabinets are producing ideal thermal conditions for quality control and research as well as development in science and industry. Experiences of almost 50 years stand for a maintenance-free construction and result in longevity.

Climatic Test Cabinets are produced in two different temperature ranges, and three unit sizes each can be chosen from. Standard test atmospheres according to DIN 50014 and constant test atmospheres according to DIN 50015 can be run in the standard units. The options temperature- and humidity programme control ensure the test method in damp alternating atmospheres according to DIN 50016.

Standard atmospheres ensure attaining and maintaining of a defined state of temperature- and humidity-sensitive objects. Constant test atmospheres allow selected stress tests in the range of tempered, damp or dry heat atmospheres for testing of temperature- and humidity-sensitive objects. The method of test in damp alternating atmospheres serves mainly for tests on units, structural components and humidity-proof packing material in view of its applicability at increased humidity of the air and temperature alternations causing condensation water or dew.

All models are equipped with artificial air circulation, if requested with control. Thus, a high temperature accuracy in space and time according to the DIN-regulation 58945 is obtained.

## 3 Transportation and Storage

The standard domestic shipment of the unit will be effected unpacked in a van. The unit should be transported carefully in standing position. In case a short-time tilting of the unit should be unavoidable, for reasons of f. ex. passing doors, it might be possible that oil of the cooling machine will enter into the evaporator. This oil must flow back to the cooling machine. For this reason take care that after transportations the unit should not be started before expiration of 4 hours. The unit is recommended to be stored in dry rooms at temperatures between +10°C and +30°C. The shipment within European countries is mostly effected in stable cartons on a palette. Seaworthy and air-freight cases are generally conserved for 12 months and the units are welded in an aluminium wrapping. Condensation due to passing of different climatic zones is avoided by drying agent bags which are to be removed prior to initial starting of the machine.



## 4 Installation

Model	Volume [l]	Exterior Dimensions [mm]			Maximum load per Insertion Grid (kg)
		Height	Width	Depth	
4001	200	1170	760	1020	25
4101	320	1650	760	1020	25
4201	530	2100	730	970	25
4301	1060	2100	1470	970	25
4401	200	1170	760	1020	25
4501	320	1650	760	1020	25
4601	530	2100	730	970	25
4701	1060	2100	1470	970	25

- Installation places being exposed to direct sunlight, radiators and other thermal sources are to be avoided. Insufficiently ventilated rooms and room temperatures exceeding +25°C are also unsuitable.
- The distance between the wall and the backside of the unit should be at least 10 cm. Do not cover the ventilation slots; even a partial covering of the slots may lead to a heat accumulation. Uncovered ventilation slots are very important for a faultless operation of the cooling machine!
- The floor of the installation place should be even and horizontal. Slight unevennesses can be balanced by the adjustable feet of the unit.
- Units being equipped with the option "Ultrasonic Humidification" must be installed in such a way, that the test room bottom is in level position to ensure a correct drain of water.

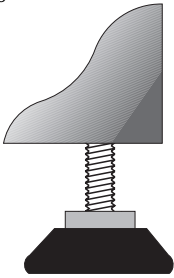
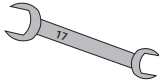
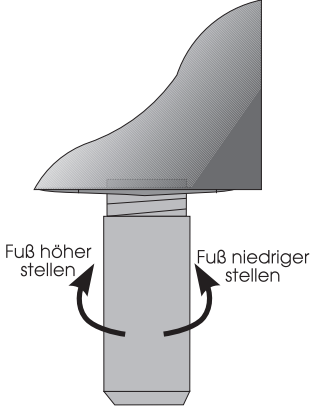
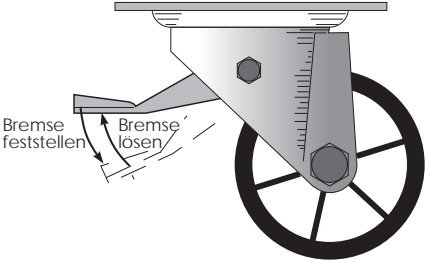
Model	Type of feet	Tool
<p>4001/4101 4401/4501</p>	<p>4 adjustable feet</p> 	<p>fork wrench SW17 (width: 17mm)</p> 
<p>4201/4301 4601/4701</p>	<p>4 adjustable feet</p> 	<p>turn foot by hand</p>
<p>Movable design on request</p>		<p>not adjustable</p>

## 5 Power Supply

- Current (A.C.) and voltage at the installation place must coincide with the indications on the name-plate of the unit. The name-plate can be found at the upper part in the door frame on the left side.
- Connection is to be made to a duly earthed socket (a separately secured socket is recommended).  
A multitude of units are equipped with combined universal plugs according to the German or French standard.

## 6 Operation

It is recommended to clean the interior of the unit before starting. Refer to the details described in "Defrosting" and "Cleaning" (chapter 12).

Open the door widely for removal of the insertion grids. The grids must be charged in such a way that a circulation of the air will not be hindered.

***The unit is not explosionproof!***  
*Do not store explosive or easily inflammable substances in the test room!*

The white rocker switch "Circulating Air" starts the fan and the unit at the same time. Cooling machine and heating are locked by means of this switch and will be only started when the fan is in operation. On operation of the fan the white pilot lamp is lighting.

In case the fan is fitted with a potentiometer, the air quantity can be reduced by turning the control knob to the left.

The red rocker switch "Heating" and the blue rocker switch "Cooling" are to be switched-on.

The refrigerating machine will only start when cooling capacity is requested. On demand of cooling, the temperature controller switches to the cooling circuit by means of a solenoid valve, and when there is no request for cooling, it switches to the bypass-circuit. Should the period where no cooling is requested exceed 3 minutes, the refrigerating machine will be switched-off. The blue pilot lamp will only light-up on request of cooling capacity (cooling circuit is switched-on), the pilot lamp "heating" will only light-up on request of heating capacity.

The test room socket (option) is switched-on by means of the yellow rocker switch ("plug socket") and the pilot lamp is lighting. The test room socket can be charged by max. 4 Amps. In case of an overload or a failure of the connected unit, the safety cut-out being located next to the switch on the right side will be released. Upon repair of the failure, the pin of the safety cut-out shall be pressed down again.

## 7 Temperature Control

### 7.1 Temperature Controller

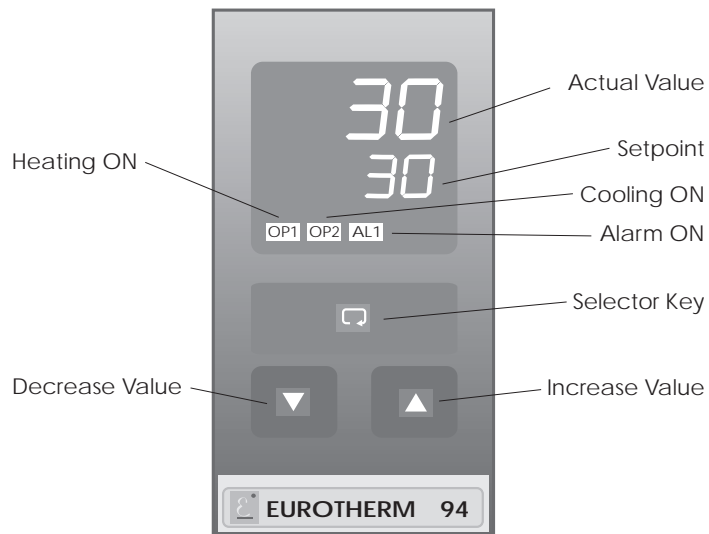

#### Functioning

The digital temperature controller can be used as constant value controller or, with optional accessories, as programme controller. Temperature sensor is a Pt 100 resistance thermometer, class A. Further technical details can be drawn from the EURO THERM Installation and Operation Manual Doc. No. HA133905, Issue 2.





### 7.2 Setpoint Control

The temperature controller keeps the test room temperature constant on an adjusted value. Actual value and setpoint are displayed simultaneously on two different digital displays being located upon another. The upper digits indicate the actual value, the lower digits the setpoint.

The control panel is a so-called "Touch Display", i. e. the operating elements will not be visible until the display zone will be touched by the operator. Decrease or increase of the setpoint is effected by means of the keys  and . If the display had not been touched for some seconds, the lighting of the keys will be switched-off.

### 7.3 Programme Control

The option dual setpoint daily programme is achieved by configuration of the temperature controller as programme controller with two setpoints. This option offers the possibility of a change between two temperatures. The temperature variation speed (ramps) is factory-adjusted to 1 °C/min. The programme can be started at any desired moment by the switching command (1 ON) of the timer. Thus, the second setpoint will be activated which is controlled with a speed of 1 °C/min. "SP.rr" flashes in the display ("Sp.rr" flashes only, when a ramp had been defined; otherwise "SP2" is displayed). Now the value for the second setpoint can be modified by means of the keys  and . The switching-off command (1 OFF) of the timer terminates the programme execution, and the first setpoint will be reactivated. The temperature variation speed is 1 °C/min until the first setpoint is reached. Now a modification of the first setpoint is again possible.

Summary:

Status of the timer="OFF"	← SP1 can be modified
Status of the timer="ON"	← SP2 can be modified

The timer can be operated in the switching modes "Auto", "Permanent ON" and "Permanent OFF". For programme control, the timer must be switched to position "Auto". For a commutation to setpoint control, the timer must be switched to "Permanent OFF". The controller will then be operated as setpoint controller and all the programmed parameters will be kept in the controller as well as in the timer.

As soon as the timer is commutated again to "Auto", the programme control is reactivated (See chapter 7.4 "Programme Timer for Alternating Temperature" -> "Change of Switching Status").



### 7.4 Programmable Timer for Alternating Temperatures

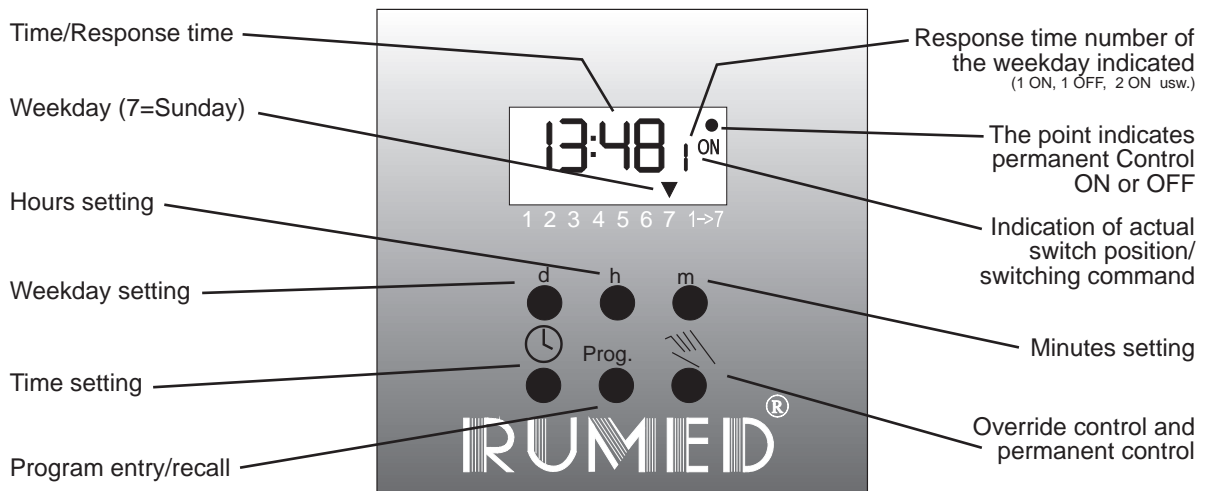







#### General

The digital timer can be operated in the operating modes "daily programme" and "weekly programme". It is recommended to programme the daily reiterating day-/night temperature change in the operating mode "daily programme". (The small triangle in the display must aim to 1->7; if not, the "weekly programme" of the timer is activated. Change of the operating mode is effected by a reset of the timer.

Reset of the Timer and Selection of the Mode "Daily Programme"		
Please observe the following four steps <b>exactly</b> for starting the timer in the daily programme mode.		
		Press the four keys simultaneously to reset the timer (can be read at the display)
- none -		Let the keys loose, and the display test will be finished
		Press and hold the key with the clock sign and set the actual hour by means of the key h. <b>(our example: 13)</b>
		Press and hold the key with the clock sign and set the actual minutes by means of the key m. <b>(our example: 48)</b>
After having entered the actual time, let the key with the clock sign loose and the timer will run.		

Change-over from Summer- to Winter Time	
	press keys simultaneously, and time is put on by an hour (summer time)
	press keys simultaneously, and time is put back by an hour (winter time)















Change of the Switching Status		
		Clock indicates the actual time (f. ex. 13.48 h) Switching status is "Automatic OFF"
 + 		Press and hold key m and press key Hand once. The switching status will change-over to "PERMANENT ON" (display indicates a point above ON)
		Press and hold key m and press key Hand once. The switching status will change-over to "PERMANENT OFF" (display indicates a point above OFF)
		Press and hold key m and press key Hand once. The switching status will again change-over to "AUTOMATIC" (point disappears)

### Daily Programme





When the mode "daily programme" is activated, maximum 6 ON- and 6 OFF-commands can be programmed. However, for one programme cycle only 1 ON- and 1 OFF-command is required. The command ON starts the programme, the command OFF terminates the programme. At the same time, a programme reset is effected in the temperature controller, which is the only possibility for a further programme start.





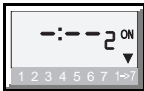

Correspondingly, the time delay between an OFF-command and the next ON-command must be at least 1 minute, otherwise the programme reset cannot be effected and the programme controller will not change to the next programme cycle (i. e. in the operating mode "daily programme" it is possible to run a four-hour programme cycle six times per day maximum).

The following table shows the programming of the response times for our dual setpoint programme example.

Programming On- and Off-Commands (Operating Mode "Daily Programme")		
		Clock indicates the actual time (f. ex. 13.48 h)
<b>Prog.</b> 		Press once, to call the programming mode (Here: f. ex. not yet programmed)
<b>h</b>  or 		Enter time for the command 1 ON by means of the keys <b>h</b> and <b>m</b> (Here: f. ex. 6.00 h)
<b>Prog.</b> 		Press once, to call the command 1-OFF (Here: f. ex. not yet programmed)
<b>h</b>  or 		Enter time for the command 1 OFF by means of the keys <b>h</b> and <b>m</b> (Here: f. ex. 21.00 h)
<b>Prog.</b> 	There are no further switching commands required for our example programme! If requested, all other switching commands can be called successively on pressing the key <b>Prog.</b> (2 OFF, 3 ON, 3 OFF, 4 ON, 4 OFF, 5 ON, 5 OFF, 6 ON, 6 OFF ← after 6 OFF, 1 ON 1 OFF etc. will be repeated)	
 		Press once, to terminate the programming mode and to return to the normal display (If there will be no entry within 30 sec., the display will automatically return to actual time).

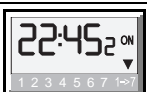
A correct execution of the programme is based on the condition, that only the required ON-/OFF-commands have been programmed. When you are not sure, if you have programmed unintentionally switching commands which are not required and which may disturb the programme flow, you can visually check the commands by calling them on the display.

Display of the Programmed ON-/OFF-Commands		
		Clock indicates the actual time (f. ex. 13.48 h)
Prog. ●		Press once, to call the programming mode. The command 1 ON will be displayed (Example programmed to 6.00 h)
Prog. ●		Press once, to call the command 1-OFF (Example programmed to 21.00 h)
Prog. ●		Press once, to call the command 2-ON (Here: f. ex. not yet programmed)
Prog. ●		If requested, all other switching commands can be called successively on pressing the key Prog. <small>(2 OFF, 3 ON, 3 OFF, 4 ON, 4 OFF, 5 ON, 5 OFF, 6 ON, 6 OFF ←after 6 OFF, 1 ON 1 OFF etc. will be repeated)</small>
 ●		Press once, to leave the display mode and to return to the normal display (If there will be no entry within 30 sec., the display will automatically return to actual time).

Modifying or Cancelling the Programmed ON-/OFF-Commands		
		Clock indicates the actual time (f. ex. 13.48 h)
Prog. ●		Press the key PROG several times until the switching command to be modified is displayed (Example: press 3 times to call 2 ON)
h or m ● or ●	 	Modify the desired time by means of the keys h and m (Here: f. ex. modification to 22.45 h) or delete the command 2-ON by pressing the keys h and m simultaneously
Prog. ●		Further switching commands to be modified or deleted are called by means of the key PROG and can be modified or deleted according to the above mentioned procedure.
 ●		Press once, to terminate the programming mode and to return to the normal display (If there will be no entry within 30 sec., the display will automatically return to actual time).

### 7.5 Example for a Dual Setpoint Daily Programme

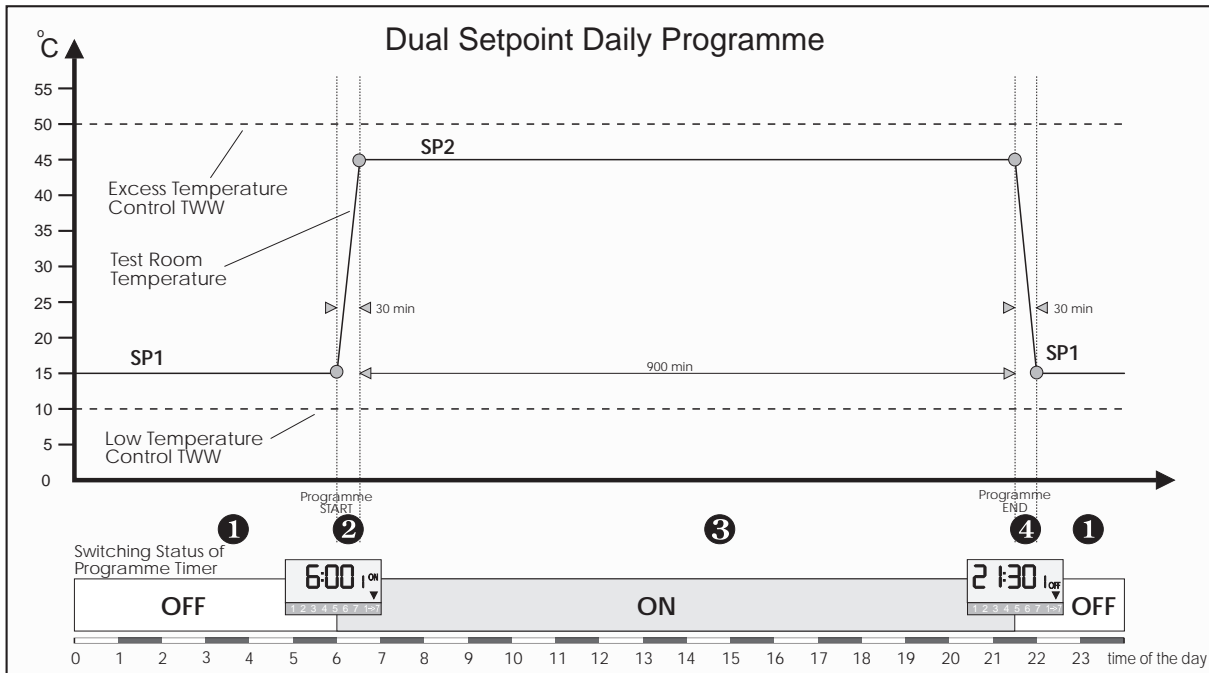

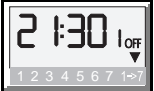



Segment	①	②	③	④	①
Function	Night Temperature	Heating	Day Temperature	Cooling	Night Temperature
SP (°C)	SP1= 15 °C	SP.rr= 1 °C/min	SP2= 45 °C	SP.rr= 1 °C/min	SP1= 15 °C
Switching Command Timer					
Switching Status	OFF	ON		OFF	

The time for the command 1 OFF is calculated as follows:

$$\text{End time} = \text{Starting time} + (\text{SP2} - \text{SP1}) / \text{Ramp slope} + \text{desired duration at SP2}$$









i. e. our example:  $6.^{00} \text{ h} + (30 \text{ °C} / (1 \text{ °C/min})) + 900 \text{ min} = 6.^{00} \text{ h} + 30 \text{ min} + 15 \text{ h} = 21.^{30} \text{ Uhr (09.30 p.m.)}$

Programming:

Adjust the setpoint (SP1) by pressing the keys  or  referring to the chapter "Setpoint Control". Then actuate the key "HAND" at the clock and switch the timer to the switching status "ON" (ON is displayed). Now "SP.rr" flashes in the display of the controller. Adjust the second setpoint (SP2) to the desired value by means of the keys  and . After that, programme the ON- and OFF-commands of the timer.

## 7.6 Example for a Dual Setpoint Weekly Programme

Most of the temperature programmes with a duration of less than 24 h can be realized in the operating mode "daily programme". However, a programme with for example a duration of 36 h, an reiterating cycle of 16 h, or a programme execution on defined week-days is only possible in the operating mode "weekly programme". The operating mode of the clock (timer) can be changed by a reset of the timer.

Reset of the Timer and Selection of the Mode "Weekly Programme"		
Please observe the following five steps exactly for starting the timer in the weekly programme mode.		
		Press the four keys simultaneously to reset the timer (can be read at the display)
- none -		Let the keys loose, and the display test will be finished
		Press and hold the key with the clock sign and set the actual day by means of the key <b>d</b> 1=Monday, 2=Tuesday usw. <b>(our example 5 for friday)</b>
		Press and hold the key with the clock sign and set the actual hour by means of the key <b>h</b> . <b>(our example: 13)</b>
		Press and hold the key with the clock sign and set the actual minutes by means of the key <b>m</b> . <b>(our example: 48)</b>
After having entered the actual time, let the key with the clock sign loose and the timer will run in the operating mode "weekly programme".		

In the operating mode "Weekly Programme", each 4 ON- and 4 OFF-commands can be programmed. For either of these switching commands the week-day for execution is to be programmed (random selection, i. e. any desired combination of week-days is possible).

For programming of the timer, as for ex. change-over from summer- to winter time, or calling or deleting of switching commands, refer to chapter "Programmable Timer for Alternating Temperatures". Observe, that programming of the ON-/OFF-commands requires programming of the respective week-days for execution of the commands.

Our following example describes the programming of a complicated weekly programme. Our example uses a 16 h-cycle being repeated 7 times running. Programming of the parameters for the temperature controller corresponds to the programming described in the chapter "Dual Setpoint Daily Programme". Programming of the switching commands for the timer are explained subsequently to the example. Note: Just as in the operating mode "daily programme", the switching commands for the clock cannot be executed retroactively!

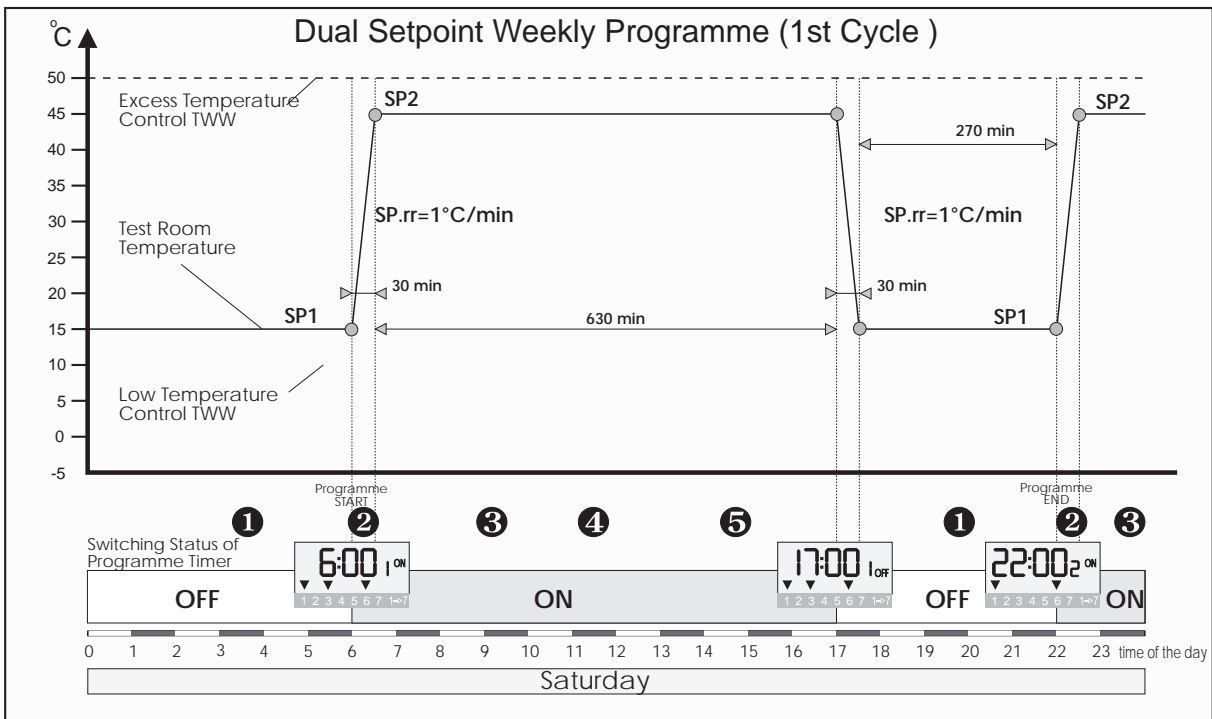
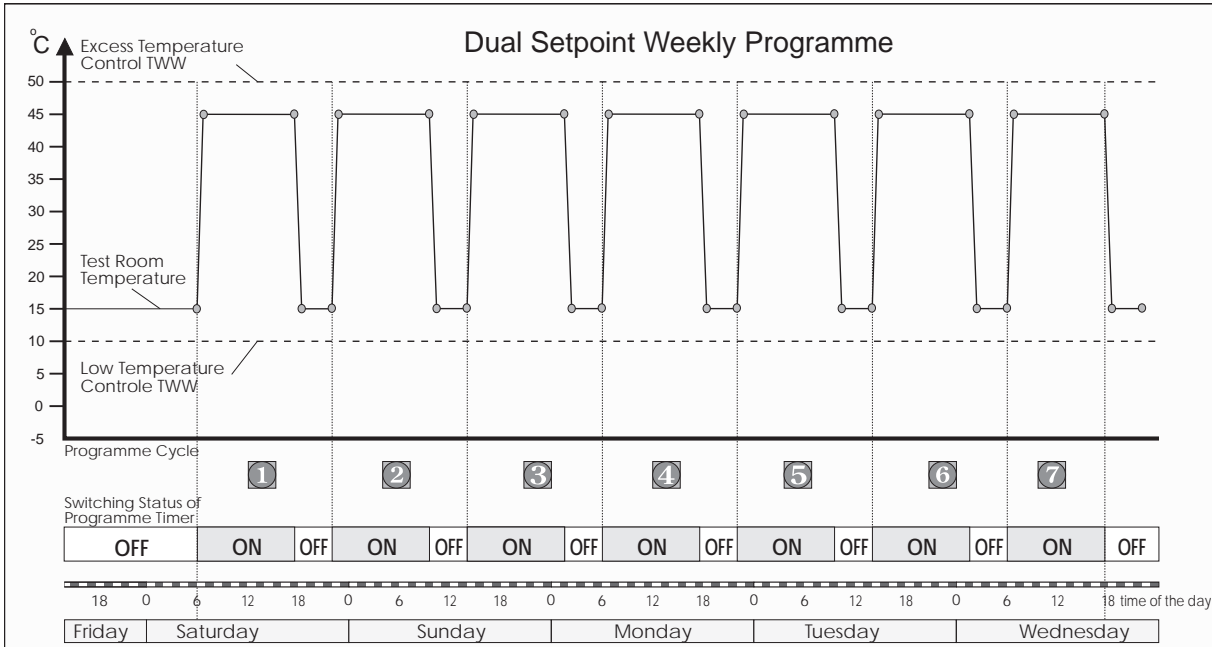

Segment	①	②	③	⑤	①
Function	Normal Temperature	Heating	Heat Load	Cooling	Normal Temperature
SP (°C)	SP1 = 15 °C	SP.rr = 1 °C/min	SP2 = 45 °C	SP.rr = 1 °C/min	SP1 = 15 °C
Switching Command Timer					
Switching Status	OFF	ON		OFF	











Execution of 7 cycles with 4 different ON- and OFF-response times each is only possible by the summarization of switching commands (so-called blocking). In our example only 3 ON- and OFF-response times each are required, because the programme is symmetric to 48 h (3 \* 16h = 48 h).

The required ON-switching commands (sunday: 6.00 h, monday: 6.00 h and wednesday: 6.00 h) are summarized to one timer switching command **1-ON**.

This summarization (blocking) offers the possibility of rather complex programmes (same time for different week-days → only 1 switching command).

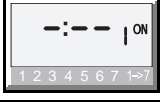
To avoid a premature programme start on termination of programming or during programming of a complicated programme, the timer can be switched to manual mode.

Change of the Switching Status	
	<p>Clock indicates the actual time (f. ex. 13.48 h) Switching status is "Automatic OFF"</p>
	<p>Press and hold key <b>m</b> and press key <b>Hand</b> once. The switching status will change-over to "PERMANENT ON" (display indicates a point above ON)</p>
	<p>Press and hold key <b>m</b> and press key <b>Hand</b> once. The switching status will change-over to "PERMANENT OFF" (display indicates a point above OFF)</p>
	<p>Press and hold key <b>m</b> and press key <b>Hand</b> once. The switching status will again change-over to "AUTOMATIC" (point disappears)</p>

Programming, Modifying or Deleting ON-/OFF-commands (Weekly Programme)		
		Clock indicates the actual time (f. ex. 13.48 h)
<b>Prog.</b> 		Press the key PROG several times until the switching command to be modified is displayed. (Example: press once to call 1 ON)
<b>d</b> or 		Press key <b>d</b> once, and a flashing arrow will be displayed above 1. Position this arrow above the desired week-day for execution of the switching command using key <b>d</b> . Acknowledge by means of the key <b>Hand</b> , and the arrow will stop flashing. Press key <b>d</b> for selection of further week-days where switching commands are to be executed and acknowledge by pressing key <b>Hand</b> . If the flashing arrow will be positioned above an already programmed arrow, this arrow will be deleted automatically, or the already programmed arrow can be acknowledged by pressing key <b>Hand</b> . Programming of the week-days with switching commands is correct, when all the desired week-days are marked with a non-flashing arrow.
<b>h</b> or <b>m</b>		Programme the command 1-ON to the desired time by means of the keys <b>h</b> and <b>m</b> . (Here : f. ex. 6.00 h)
<b>h</b> or <b>m</b>		or delete the command 1-ON by pressing keys <b>h</b> and <b>m</b> simultaneously and repeat programming of the week-day.
<b>Prog.</b> 		Use key <b>Prog.</b> for selection of possibly desired further switching commands to be programmed or deleted and refer to the above description.
		Press once, to terminate the programming mode and to return to the normal display (If there will be no entry within 30 sec., the display will automatically return to actual time).

Execution of the programme will only be effected, if the clock is in position "Automatic". If the clock had been switched to "Permanent OFF" for programming, switch-over to "Automatic" for programme execution.



## 8 Temperature Protection

### 8.1 Specimen Protection

The unit is equipped with a freely adjustable temperature selector control (TWW) for protection of the specimen to be tested. The temperature controller avoids any deviation from the adjusted temperature range possibly occurring due to malfunction. In case of over-temperature or insufficient temperature, the TWW switches-off the cooling machine and all thermal sources (as circulating fan, lighting, humidification and socket). As long as there is an overtemperature or insufficient temperature in the test room, an acoustic signal warns from supercooling or superheating. Reconnection is effected automatically when the test room temperature reaches the preadjusted temperature range. The acoustic alarm can be switched-off by the main switch or by decreasing the value of the insufficient temperature limitation or by increasing the value of the overtemperature limitation.



The limit values of the temperature range being adjusted at the temperature selector control should always be 5 °C below respectively above the temperatures being adjusted at the temperature controller.

Temperature	blue pointer	red pointer
Setpoint Control +23 °C	+18 °C	+28 °C
Programme control +15 °C/+45 °C	+10 °C	+50 °C

#### Adjustment of the Temperature Range:

- Unscrew the cover anticlockwise
- Set the blue pointer with the key side (1) to the desired value of the low temperature disconnection by turning the green ring
- Set the red pointer with the key side (2) to the desired value of the overtemperature disconnection by turning the brass screw
- Screw on the cover after having adjusted

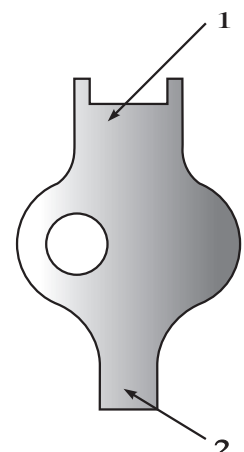

## 8.2 Unit Protection

The unit is equipped with an overtemperature protection. The measuring sensor is located in the rear test room on the right side below the ceiling. In case of overtemperature the fuse (3) bursts. The unit remains switched-off and an acoustic alarm is released additionally.

### Replacement of the Fuse:

- Hold fast the shaft (1) and unscrew the knurled screw (2).
- Carefully remove the glass splinters out of the knurled screws (2) by knocking.
- Insert the spare fuse with a releasing temperature according to the figure in the margin into the knurled screw (2). The releasing temperature is marked on the shaft of the fuse (3).
- Hold fast the shaft (1) and jam in the knurled screw (2) against the spring pressure until the thread gets hold and screw it on.

After response of the unit protection and prior to a new start of the unit, possible failures should be detected.

**Any manipulation on this protection device or the mounting of a fuse with a higher releasing temperature than:**  
+70 °C for models 4000 - 4200  
+90 °C for models 4300 - 4500  
**will destroy the unit and will result in a loss of guarantee claims.**

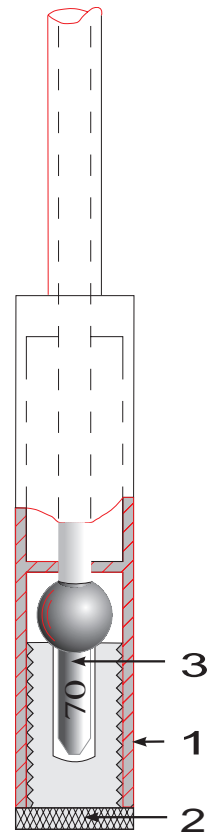

## 9 Humidification

### 9.1 Ultrasonic Humidification

#### General

The ultrasonic humidification is generating mist by means of ultrasonic waves acting upon demineralized water, and thus the air is humidified. The temperature/humidity diagram in the margin shows the working range in combination with the function dehumidification.

Connect the humidifier by means of the furnished hose to a water supply with a conductivity up to 5  $\mu\text{S}/\text{cm}$  and a conduit pressure of 0,2 - 5,0 bar.

If connection to a demineralized water supply is not possible, the demineralized water can be fed by means of a ventilating valve from a supply vessel being suspended approx. 1 m above the water level of the humidifier. The water level in the humidifier is checked by a float switch. In case of a decrease of the water level, water will be refilled by a solenoid valve.

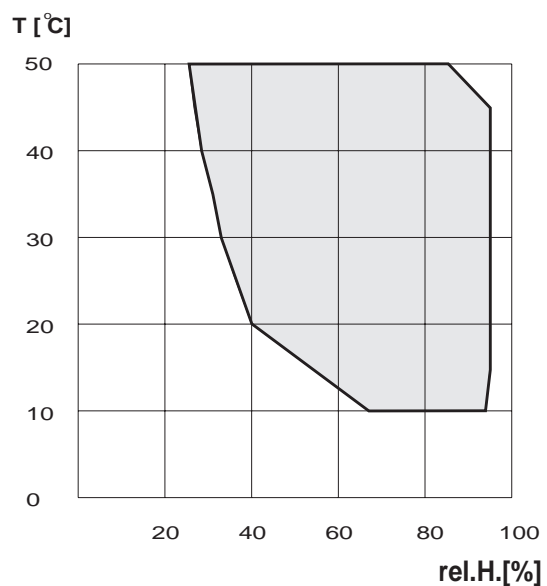

A small part of the circulating air flow is led continuously through the mist chamber of the humidifier to feed humidity to the test room when demanded by the controller. Units with temperatures below 0 °C are equipped with an additional blower to supply ambient air to the humidifier, thus avoiding freezing of the humidifier.

When exceeding 52 °C humidification is switched off by means of an alarm of the temperature controller. If not, the electronics being cooled by the water of the humidifier would be superheated. The max. atomization capacity is approx. 0,5 l/hour.



**Humidity Controller**

The adjusted humidity is kept constant by an electronic digital controller.

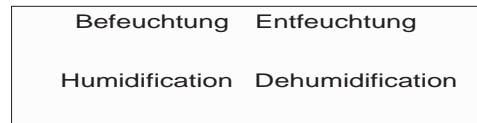
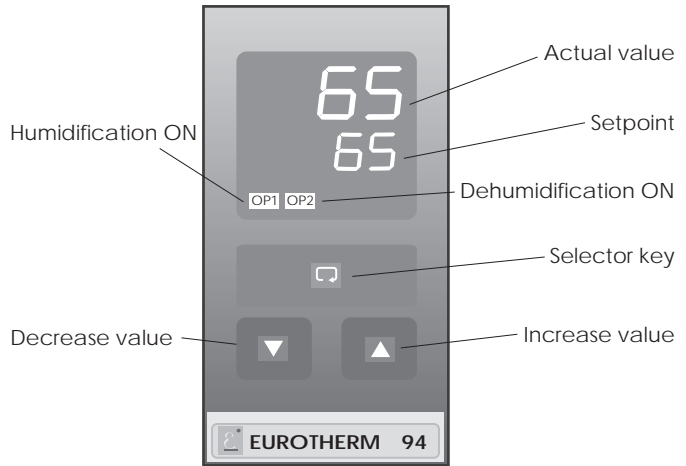
The capacitive humidity sensor consists of a dielectric, the relative permittivity of which is varying proportionally to the relative humidity. The humidity controller converts this electric variable into values of relative humidity and indicates the values on the display. The humidity sensor is almost maintenance-free and long-lasting. A calibration device can be sold or rented.



**Setpoint control**

Actual value and setpoint are displayed simultaneously on two different digital displays being located upon another. The upper digits indicate the actual value, the lower digits the setpoint. The setpoint value can be decreased or increased by pressing the keys  and .

**Programme Control**

The programming of the humidity controller and the programme timer with the option alternating humidity, can be drawn from chapter 7.3, Programme Control.

Type of water supply	Connection	Pressure	Conductivity
Connection to proper supply circuit with demineralized water	3/4 "	0,2 - 5,0 bar	5 µS/cm
Connection to tap water supply with ion exchanger connected in series	3/4 "	0,2 - 5,0 bar	
Connection to ventilated supply vessel with demineralized water	3/4 "	min. 1 m water column	5 µS/cm

## Operation of the Different Types of Water Supply

### ☛ Operation with Demineralized Tap Water

Connect water intake of the humidifier with the furnished hose to a **demineralized** water supply according to DVGW (German Supply Company for Gas/Water) which can be shut-off.

### ☛ Operation with Demineralized Water from a Supply Vessel

Suspend a ventilated supply vessel (recommended volume: 10 liters) minimum 1 m above the level of the humidifier and connect it to the water intake of the humidifier by means of the furnished hose.

### ☛ Operation with Tap Water

It is not possible to operate the humidifier with directly supplied tap water. If only tap water is available, the water must be supplied through an ion exchanger connected in series. Connect water intake of the ion exchanger with the furnished hose to a tap water supply according to DVGW (avoiding reflux) which can be shut-off.

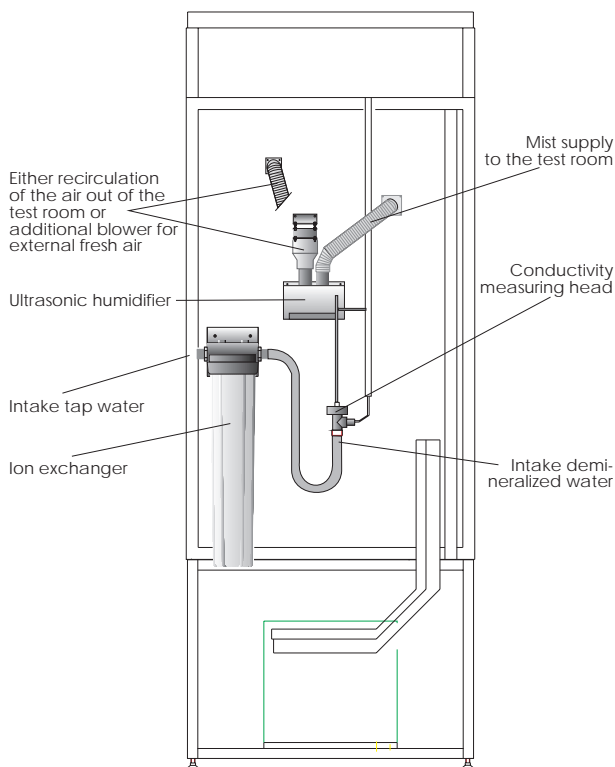

## Operation

When the humidification is switched-on by means of the green switch, the humidity controller will run a self-test. The water quality is monitored by means of a conductivity head and is displayed by means of the LED (light-emitting diode) being located left of the green switch.

Colour of the LED	Operating state	Water Quality (Conductivity)
White (LED off)	Normal state	less than 5 $\mu\text{S}/\text{cm}$
Green	Pre-alarm	between 5 and 20 $\mu\text{S}/\text{cm}$
Red	Alarm state and automatic cut-off	more than 20 $\mu\text{S}/\text{cm}$

In case of a conductivity of more than 20  $\mu\text{S}/\text{cm}$ , the humidifier will be cut-off automatically avoiding damage of the oscillator (transducer) and soiling of the test room by mineral deposits.

When the LED is lighting red at the initial start, rinse the hoses, manifolds and the humidifier vessel from deposits which may exist from production process.

### Rinsing of the Humidifier and the Hoses before Initial Start or After Erroneous Operation with Tap Water

- Rinse with switched-on unit
- Loosen hose clamp of the right hose (OUT) on the humidifier and pull off hose
- Suck water out of the water vessel through this opening
- The unit will refill automatically demineralized water
- Repeat procedure until LED is lighting green (only pre-alarm)
- Reattach hose and tighten hose clamp

After some days (dependent on the water consumption and the dilution resulting from), the green LED will be switched-off.

### Replacement of the Tube Filter in the Ion Exchanger

When the tube filter of the ion exchanger is spent (when the red LED is lighting at the latest, rather before) it must be replaced.

- Close the stop valve of the water supply of the humidifier and loosen hose from the cock to reduce the overpressure
- Place vessel or bucket as collecting basin below the ion exchanger, as undetermined water might penetrate when replacing the tube filter
- Loosen the lower, blue water vessel of the ion exchanger by turning it clockwise (☞ water may penetrate)
- Evacuate water vessel and withdraw tube filter out of the water vessel
- Insert new tube filter in the same position (☞ the end with the packing ring aims upwards)
- Carefully screw-on (fingertight) blue water vessel (without force), avoiding jamming
- Reconnect water supply hose
- Open stop valve and check tightness of the water vessel screwing (☞ if leaky, replace O-ring in the thread of the blue water vessel)
- Order spare tube filter! Spent tube filters are taken back for regular recycling free of charge, on the condition that they will be sent to the works in D-Laatzten freight prepaid.



## 9.2 Dehumidification

Dehumidification is generated by falling below the dewpoint. If the humidity controller demands dehumidification power, refrigerant is led to the lower part of the heat exchanger. When falling below the dewpoint, the water vapour in the air condenses. The precipitated water drops off from the heat exchanger lamellae and leaves the test room through the condensate drain.

The orange switch below the humidity controller switches on the dehumidification and the orange pilot lamp in the switch will light up. If the value being adjusted at the humidity controller is exceeded by more than the switching hysteresis, the dehumidification system is automatically switched-on and the pilot lamp "Dehumidification ON" in the controller will light up.

## 10 Service and Maintenance

### Defrosting

- Place a condensate collector below the floor drain which is to be emptied if filled with dew water.
- Continuous operation with coldest thermostat adjustments might cause icing or hair-frost on the evaporator. Then a periodical defrosting of the evaporator is necessary. For this purpose, set temperature controller to +20°C and remove the specimen.

After having defrosted, clean the unit and adjust the temperature controller onto the desired temperature.

**Do not remove hair-frost or icing with sharp objects,  
as the evaporator might be damaged!**

### Cleaning

It is recommended to clean the unit regularly.

**For supply isolation of the unit, unplug the mains plug from the socket or switch-off (remove) the fuses connected in series!**

Clean the **test room and the exterior housing** with tepid water and a scavenger. Rinse with clear water and dry well.

Do not use cleansing agents comprising sand or solvents!

### Cooling Machine

To obtain a high output with a low energy consumption at the same time, it is necessary to clean the heat exchanger from time to time from dust particles. In rooms being less dustladen a cleaning once or twice a year is sufficient.

- **Unplug mains plug from the socket!**
- Clean heat exchanger (black wire grating) at the back-side of the unit with a pencil, hand-brush or a vacuum-cleaner. Care should be taken that no cables are torn off or tubes are bended or cracked.

### Putting out of Operation

If the unit shall be out of operation for a longer period, the mains plug is to be unplugged from the socket or the fuses connected in series are to be switched-off (removed)! Furthermore, the door should remain open during the out of operation period to avoid any odours.